



PROTOS



2024

ADJUTOR RIGGING GEAR

PROTOS has a history of looking at the demands from the market when deciding what direction to take in terms of the products we offer. In our biggest update since our inception, we offer an extensive line of high end Rigging Gear, a complete solution for any project.

The greatest strength of the ADJUTOR Rigging Gear line is our ability to tailor make the products in this line to fit your exact needs, while lead times of customized products are short and reliable.

Only high quality materials are used and manufacturing and assembly is handled by skilled professionals specializing in working with a diverse selection of products, often using specially designed machinery and tools.

Our entire ADJUTOR line is ISO 9001 certified, maintaining our focus on quality as well as safety.

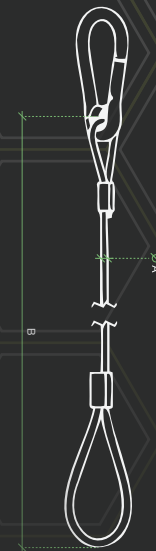
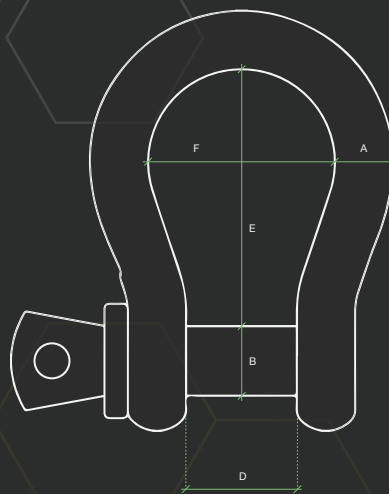

31.75 mm
38.10 mm
50.80 mm

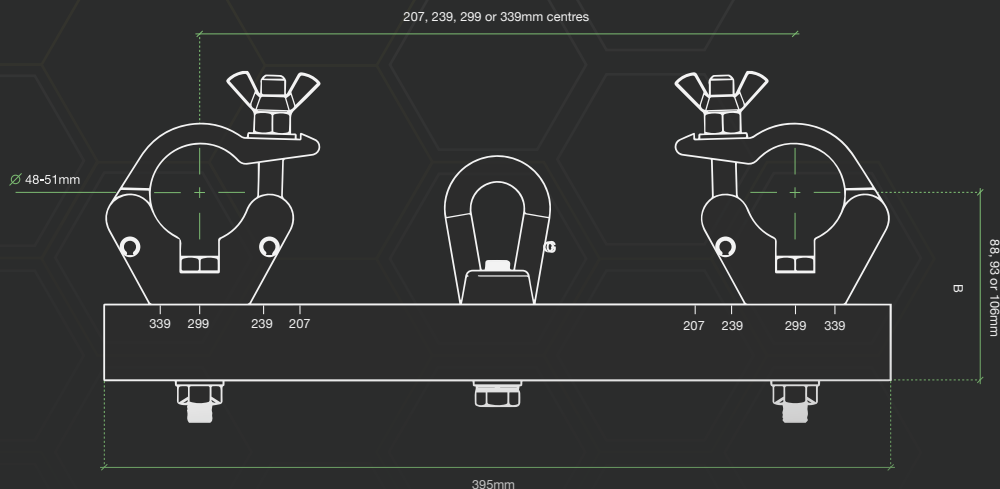

Shackles	4
Softsteels	8
Roundslings	8
Universal Lifting Brackets	9
Beam Clamps	10
Ratchets and Straps	10
Steels	11
Safety Bonds	12
Chainclutches	13
Manual Chain Hoists	14
Chain Sliders	15
Softsteel Protector	16
Zip Clip	17



PROTOS

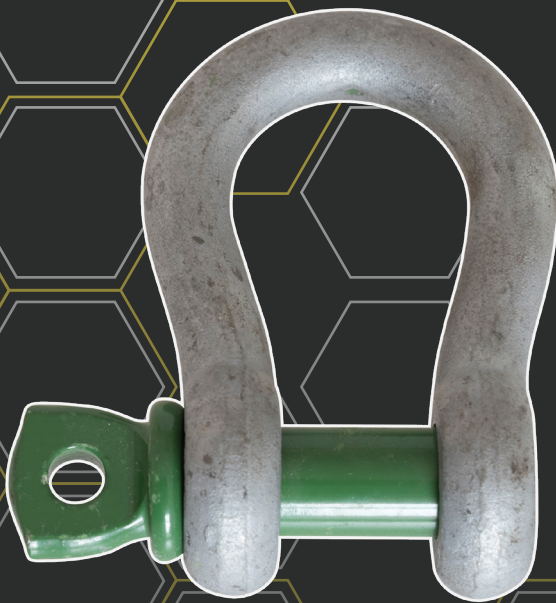

PROTOS SCREWPIN BOWSHACKLE

Material: Grade 6 | **Safety factor:** MBL equals 6 x WLL | **Standard:** EN 13889 and meets performance requirements of US Fed. Spec. RR-C-271 Type IVA Class 3, Grade A from 2T and upward these shackle comply with ASME B30.26

Finish: Hot dipped galvanized | **Temperature range:** -40 C up to +200 C | **Certification:** 2.1 2.2 3.1 MTC a DNV 2.7-1 a DNV2.7-1 b DNV 2.22 CE

ART.NR	WLL Ton	A mm	B mm	C mm	D mm	E mm	F mm	kg/pc
PRVHBBG00500	0,5	7	8	16,5	12	29	20	0,06
PRVHBBG00750	0,75	9	10	20	13,5	32	22	0,11
PRVHBBG01000	1	10	11	22,5	17	36,5	26	0,16
PRVHBBG01500	1,5	11	13	26,5	19	43	29	0,22
PRVHBBG02000	2	13,5	16	34	22	51	32	0,42
PRVHBBG03250	3,25	16	19	40	27	64	43	0,74
PRVHBBG04750	4,75	19	22	46	31	76	51	1,18
PRVHBBG06500	6,5	22	25	52	36	83	58	1,77

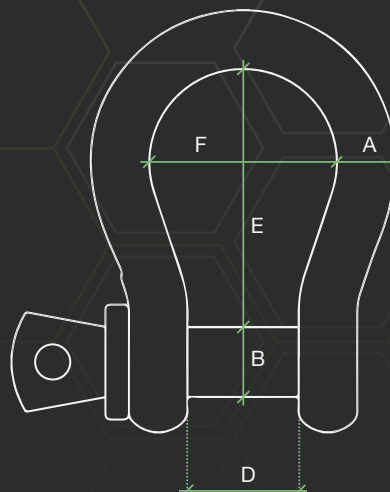

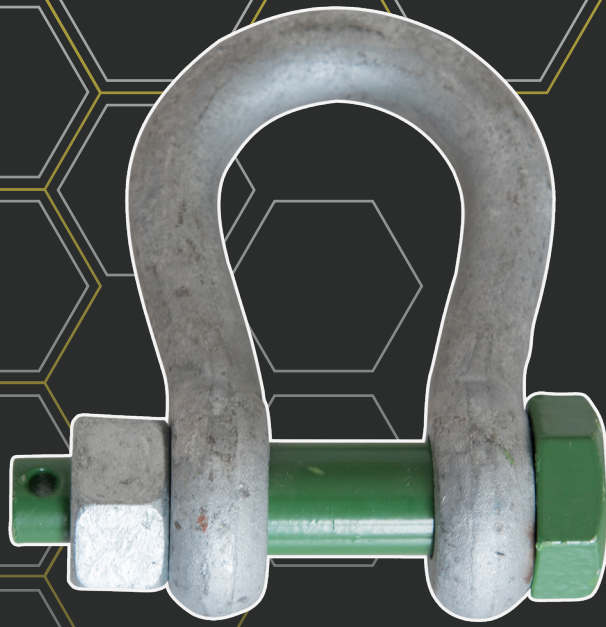

PROTOS SAFETY BOLT BOWSHACKLE

Material: Grade 6 | **Safety factor:** MBL equals 6 x WLL | **Standard:** EN 13889 and meets performance requirements of US Fed. Spec. RR-C-271 Type IVA Class 3, Grade A from 2T and upward these shackle comply with ASME B30.26

Finish: Hot dipped galvanized | **Temperature range:** -40 C up to +200 C | **Certification:** 2.1 2.2 3.1 MTC a DNV 2.7-1 a DNV2.7-1 b DNV 2.22 CE

ART.NR	WLL Ton	A mm	B mm	C mm	D mm	E mm	F mm	kg/pc
PRVHBBG00330	0,33	5	6	12	9,5	22	16	0,02
PRVHMBG00500	0,5	7	8	16,5	12	29	20	0,06
PRVHMBG00750	0,75	9	10	20	13,5	32	22	0,11
PRVHMBG01000	1	10	11	22,5	17	36,5	26	0,16
PRVHMBG01500	1,5	11	13	26,5	19	43	29	0,22
PRVHMBG02000	2	13,5	16	34	22	51	32	0,42
PRVHMBG03250	3,25	16	19	40	27	64	43	0,74
PRVHMBG04750	4,75	19	22	46	31	76	51	1,18
PRVHMBG06500	6,5	22	25	52	36	83	58	1,77

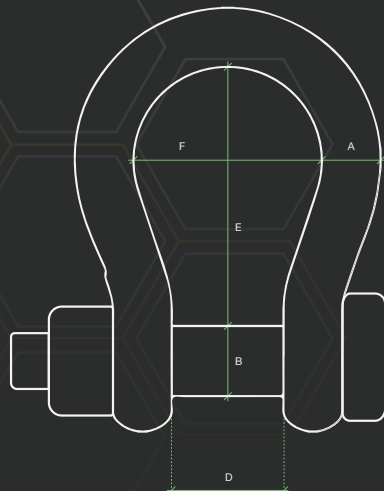



PROTOS BLACK SCREWPIN BOWSHACKLE

Material: Grade 6 | Safety factor: MBL equals 6 x WLL | Standard: US Fed. Spec. RR-C-271 | Finish: matt black
 Certification: 2.1 2.2

ART.NR	WLL Ton	A mm	B mm	C mm	D mm	E mm	F mm	kg/pc
SLZHBBZ00330	0,33	5	6	15	9,5	22	16	0,02
SLZHBBZ00500	0,5	6	8	18	12	28	19	0,07
SLZHBBZ00750	0,75	8	10	22	13,5	32	21	0,13
SLZHBBZ01000	1	10	11	26	17	35	25	0,17
SLZHBBZ01500	1,5	11	13	28	19	42	29	0,25
SLZHBBZ02000	2	13	16	32	20	47	32	0,44
SLZHBBZ03250	3,25	16	19	39	27	60	43	0,79
SLZHBBZ04750	4,75	19	22	47	32	71	50	1,26

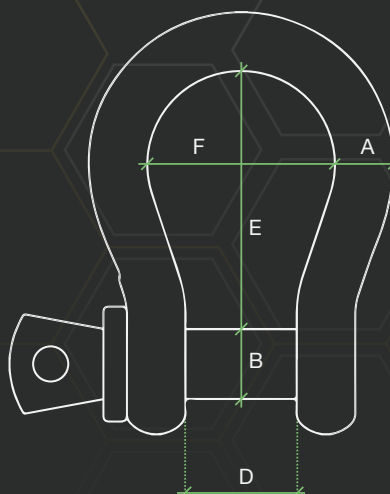

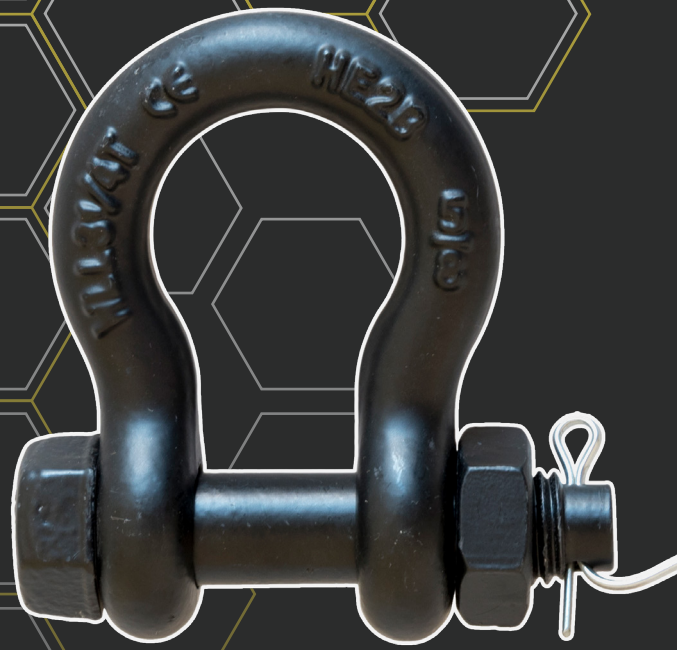

PROTOS BLACK SAFETY BOLT BOWSHACKLE

Material: Grade 6 | Safety factor: MBL equals 6 x WLL | Standard: US Fed. Spec. RR-C-271 | Finish: matt black
 Certification: 2.1 2.2

ART.NR	WLL Ton	A mm	B mm	C mm	D mm	E mm	F mm	kg/pc
SLZHMBZ02000	2	13	16	32	21	49	33	0,42
SLZHMBZ03250	3,25	16	19	39	27	59	42	0,74
SLZHMBZ04750	4,75	19	22	47	32	73	50	1,18

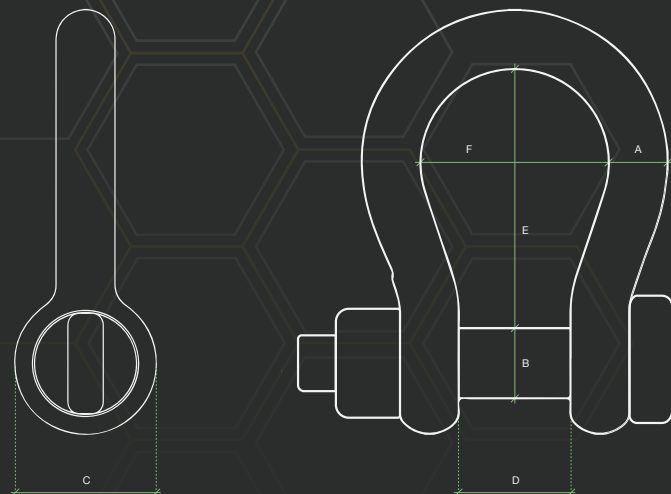



PROTOS SOFTSTEELS

Flexible alternative to steels | Comes with a black polyester sleeve and a steel wire rope core | Safety factor 5:1 | Approved for BGV C1 / DGUV | Custom configurations available on request

PROTOS ROUNDSLINGS

Various lengths available | 100% traceability due to unique number on labels | Safety factor 7:1 | According to NEN-EN 1492-2 | Custom configurations available on request

ART.NR	WLL	L
PRHRS02000501	2 Ton	0,5
PRHRS02001001	2 Ton	1
PRHRS02001501	2 Ton	1,5
PRHRS02001601	2 Ton	1,6
PRHRS02002001	2 Ton	2
PRHRS02002501	2 Ton	2,5
PRHRS02003001	2 Ton	3

ART.NR WLL	WLL	L
PRHRP01000501	1 Ton	0,5
PRHRP01001001	1 Ton	1
PRHRP01001501	1 Ton	1,5
PRHRP01002001	1 Ton	2
PRHRP01002501	1 Ton	2,5
PRHRP01003001	1 Ton	3
PRHRP01003501	1 Ton	3,5
PRHRP01004001	1 Ton	4
PRHRP02000501	2 Ton	0,5
PRHRP02001001	2 Ton	1
PRHRP02001501	2 Ton	1,5

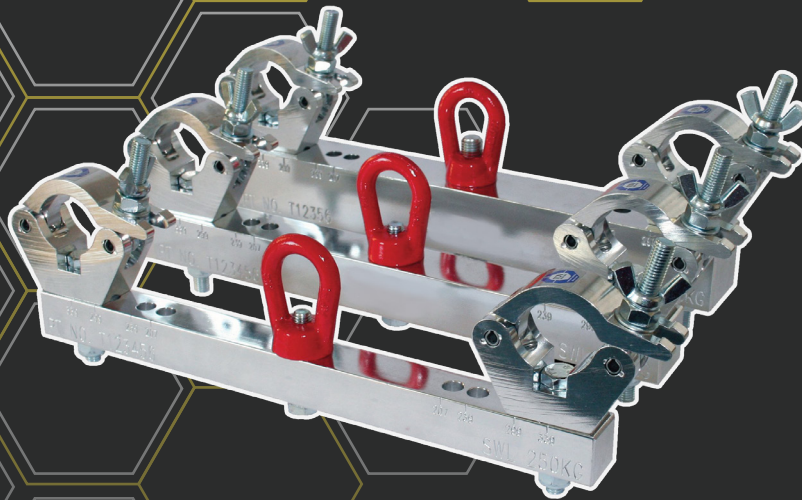

PROTOS UNIVERSAL LIFTING BRACKET

Manufactured from solid high tensile aluminium | Solid Hanging Truss adaptor features a 'Bow Nut' to accommodate larger hooks | Truss adaptor is pre-drilled to fit most major brands of truss | Comes fitted with two Slimline Doughty Clamps

ART.NR	WLL kg	A mm	B mm	Color	kg/pc
PRD55720	250	31.75	88	Silver	4
PRD55725	250	31.75	88	Black	4
PRD55750	500	38.1	93	Silver	4
PRD55755	500	38.1	93	Black	4
PRD55780	1000	50.8	106	Silver	4
PRD55785	1000	50.8	106	Black	4

207, 239, 299 or 339mm centres

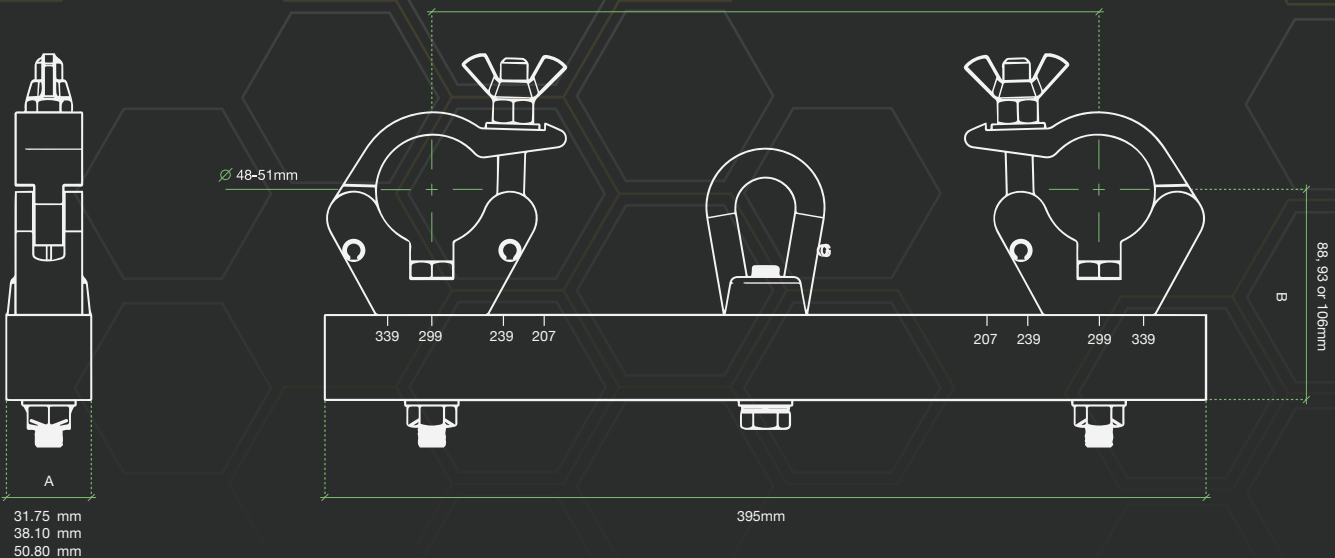

A
31.75 mm
38.10 mm
50.80 mm

395mm

B
88, 93 or 106mm

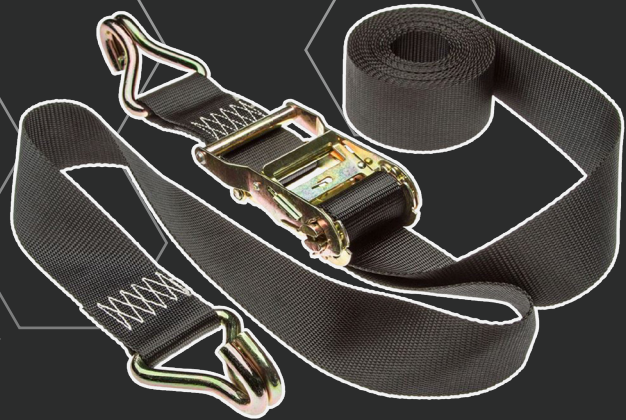
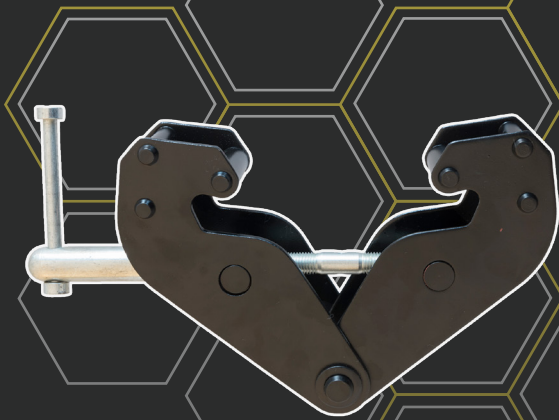

PROTOS BEAMCLAMP

Colour: black | Easy installation | Suitable as both a temporary as well as a permanent lifting point

ART.NR	WLL Ton	beam width mm	f min mm	f max. mm	Ø axle mm	kg - pc
BALKRB00011	1	75 - 230	150	90	19	3,5
BALKRB00022	2	75 - 230	150	90	21	4,5
BALKRB00033	3	80 - 320	220	145	23	9,5

PROTOS RATCHET SET

Various lengths available | Available as 2 part ratchet strap or endless ratchet strap model

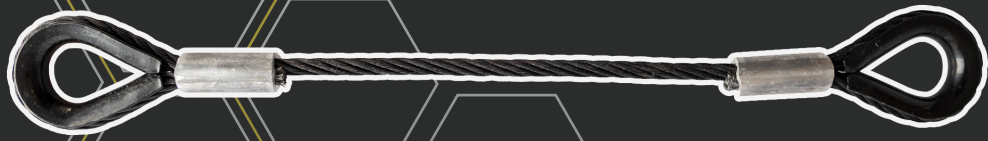

PROTOS STEELS

Standard in construction 6x36WS+IWRC dry | Pressed with standard aluminium ferrules | Both sides with a stub-end thimble | 1T steels with oversized thimble suitable for a 3,25T shackle | 2T steels with oversized thimble suitable for a 4,75T shackle | Certificate available | Other configurations available on request

Silver	A - ø in mm	Black	A - ø in mm	B in mtr	C	D	WLL Ton
PRS10000502	10	PRZ10000500	10	0,5	57	35	1
PRS10000752	10	PRZ10000750	10	0,75	57	35	1
PRS10001002	10	PRZ10001000	10	1	57	35	1
PRS10001502	10	PRZ10001500	10	1,5	57	35	1
PRS10002002	10	PRZ10002000	10	2	57	35	1
PRS10002502	10	PRZ10002500	10	2,5	57	35	1
PRS10003002	10	PRZ10003000	10	3	57	35	1
PRS10004002	10	PRZ10004000	10	4	57	35	1
PRS10005002	10	PRZ10005000	10	5	57	35	1
PRS10006002	10	PRZ10006000	10	6	57	35	1
PRS10007502	10	PRZ10007500	10	7,5	57	35	1
PRS10008002	10	PRZ10008000	10	8	57	35	1
PRS10010002	10	PRZ10010000	10	10	57	35	1
PRS14000652	14	PRZ13000500	13	0,65	65	45	2
PRS14000752	14	PRZ13000750	13	0,75	65	45	2
PRS14001002	14	PRZ13001000	13	1	65	45	2
PRS14001502	14	PRZ13001500	13	1,5	65	45	2
PRS14002002	14	PRZ13002000	13	2	65	45	2
PRS14002502	14	PRZ13002500	13	2,5	65	45	2
PRS14003002	14	PRZ13003000	13	3	65	45	2
PRS14004002	14	PRZ13004000	13	4	65	45	2
PRS14005002	14	PRZ13005000	13	5	65	45	2
PRS14006002	14	PRZ13006000	13	6	65	45	2
PRS14007502	14	PRZ13007500	13	7,5	65	45	2
PRS14008002	14	PRZ13008000	13	8	65	45	2
PRS14010002	14	PRZ13010000	13	10	65	45	2



PROTOS SAFETY BONDS

Black steel wire rope bond with soft loops at each end | Comes with a spring hook at one end | Custom configurations available on request

ART.NR	WLL kg	A - ø mm	B cm	Carbine
PRT2840001	5	2	50	M4
PRT22001	15	3	58	M4
PRT22101	15	3	58	M4
PRT2841001	20	2	60	M6
PRT220025	25	3	58	M6
PRT2820501	50	4	70	M8
PRT2844001	36	4	60	M8
PRT2844501	36	4	100	M8
PRT2849001	36	4	100	-

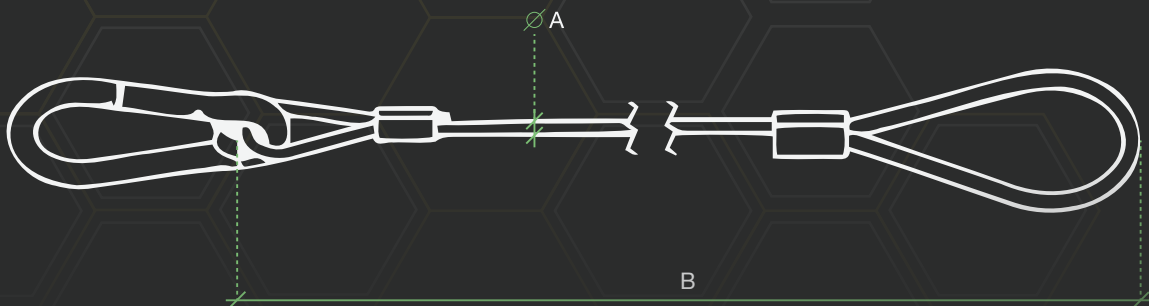



PROTOS CHAINCLUTCH

Black components | Grade 80 EN818-2 chain | Fitted with master link and clevis hook | Certificates available | Four standard variants: shortening clutch with safety, grabhook with safety, shortening clutch without safety and grabhook without safety

Shortening Clutch With Safety	Grabhook With Safety	Shortening Clutch Without Safety	Grabhook Without Safety	WLL Ton	A mm	B mm
RDBCZ0601000	RDBCZ0601001	RDBCZ0601002	RDBCZ0601003	1	6	1
RDBCZ0602000	RDBCZ0602001	RDBCZ0602002	RDBCZ0602003	1	6	2
RDBCZ0603000	RDBCZ0603001	RDBCZ0603002	RDBCZ0603003	1	6	3
RDBCZ0801000	RDBCZ0801001	RDBCZ0801002	RDBCZ0801003	2	8	1
RDBCZ0802000	RDBCZ0802001	RDBCZ0802002	RDBCZ0802003	2	8	2
RDBCZ0803000	RDBCZ0803001	RDBCZ0803002	RDBCZ0803003	2	8	3



PROTOS MANUAL CHAIN HOIST

Colour: black | Galvanized high tensile steel chains | 15 Meters standard lifting and operating height
| Custom lengths available

ART.NR	WLL Ton	a	b	c	d	e
RBTAKHSZ00500	0,25	4x12	3x15	215	0,63	2
RBTAKHSZ00500	0,5	5x15	5x24	220	1,5	3,25
RBTAKHSZ01000	1	6,3x19	5x24	360	1,8	6

- a diameter lifting chain
- b diameter operating chain
- c force on operating chain at full load
- d weight chain per meter
- e weight body without chain



PROTOS CHAINSLIDERS

Simple yet versatile, the PROTOS tour- and chainlides are a solution for hoist cable management that's both easy to install and remove. Never worry about bunched up or loose hanging cables again with this convenient product.

These slide easily onto a **non-load bearing** chain. The product comes in **three sizes** to accommodate all mainstream hoist chains. **Connect your cables** to the slides with cable-ties or standard 0,5t shackles.

ART.NR

a

PR500-244200	4,0-5,5mm
PR500-244201	6,1-7,2mm
PR500-244202	7,9 - 9,0mm
PR500-244203	10 - 13mm

a Compatible chain diameter

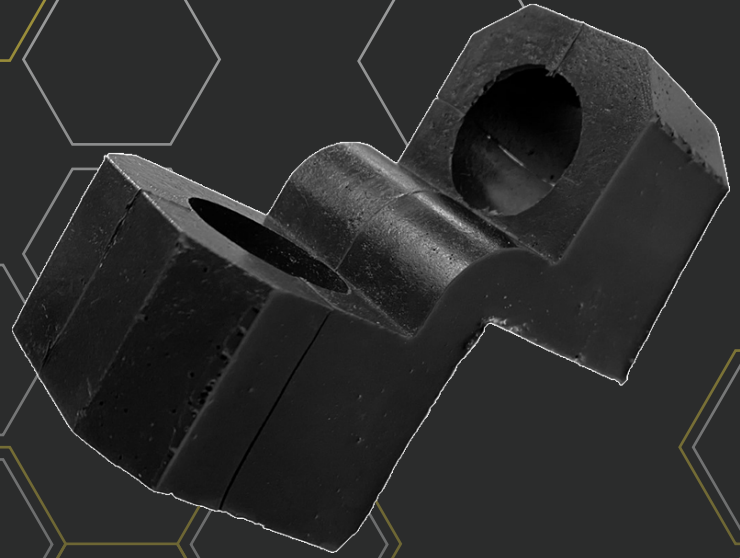

PROTOS SOFTSTEEL PROTECTOR

Engineered specifically for softsteels
Made from self extinguishing rubber

ART.NR	a mm	b mm	c mm	d mm	KG
RBSSB01	28	55	105	48	0,18

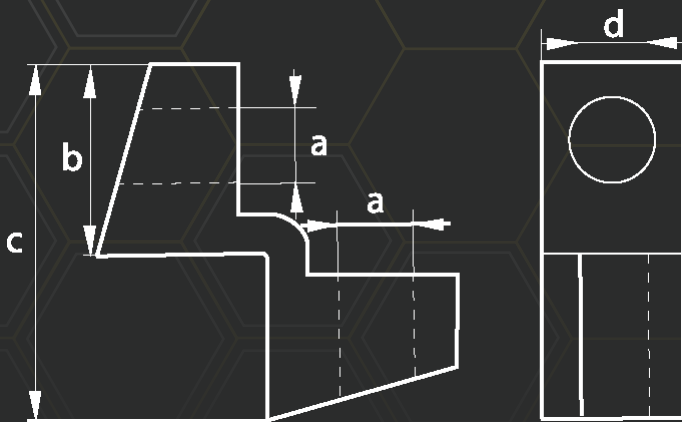



PROTOS ZIP CLIP

The **ADJUTOR Zip Clip** is an easy way to make a loop into a wire rope. The clips are adjustable and designed with **quality** and **safety** as key aspects. All clips are tested the 3rd parties **TÜV, MELBTEST, SATRA, British Lloyds, NATA** and **APAVE**. Aside from that all items are **UL certified**. The Zip Clips are used on **Galvanized** and **stainless steel** wire ropes.

ART.NR standard / black	Rope mm	WLL kg
-------------------------	---------	--------

ZCRIZE00120 / ZCRIZE00120Z	1,2	15
ZCRIZE00200 / ZCRIZE00200Z	2	50
ZCRIZE00300 / ZCRIZE00300Z	3	120
ZCRIZE00400 / ZCRIZE00400Z	4	300
ZCRIZE00600 / ZCRIZE00600Z	6	500

ART.NR lockable / lockable black	Rope mm	WLL kg
----------------------------------	---------	--------

ZCRIZEL00200 / ZCRIZEL00200Z	2	50
ZCRIZEL00300 / ZCRIZEL00300Z	3	120
ZCRIZEL00400 / ZCRIZEL00400Z	4	300
ZCRIZEL00600 / ZCRIZEL00600Z	6	500

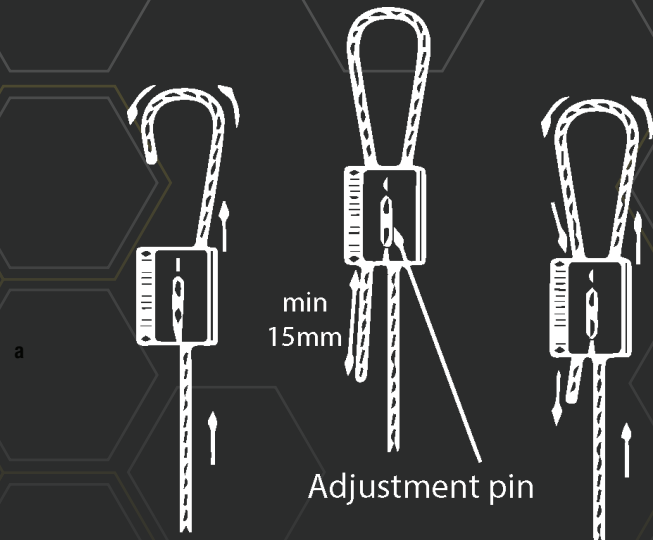

PLUS ON WIRE

The Plus on Wire is specifically engineered to be used in standard profiles. Easy to mount on the wire rope, twist and secure for correct assembly. With a safe working load of 100 kg in combination with a 4 mm wire rope. The Plus on Wire is also available in black.

ART.NR standard / black	Rope mm	WLL kg
-------------------------	---------	--------

ZCPLOW00400 / ZCPLOW00400Z	4	100
----------------------------	---	-----

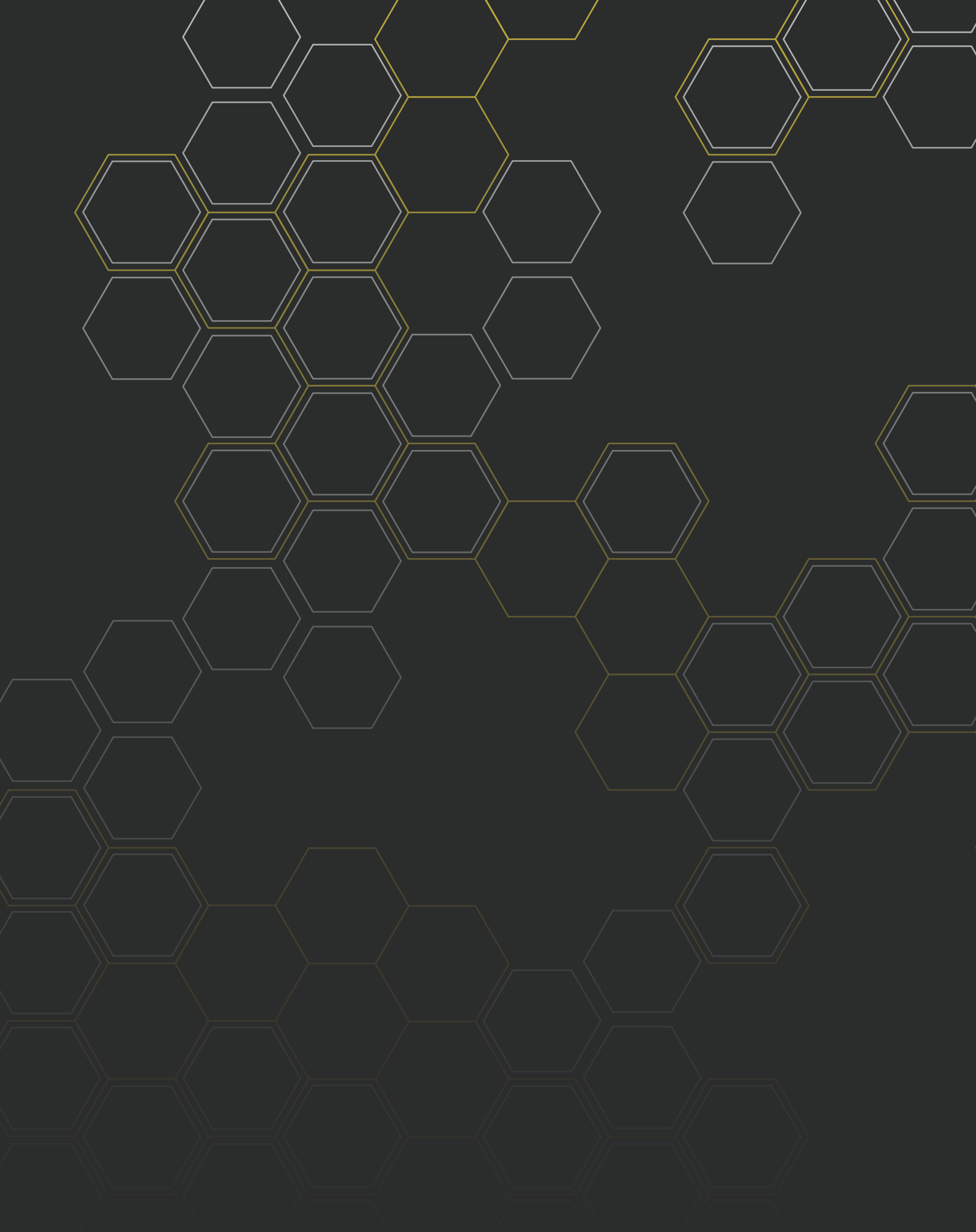

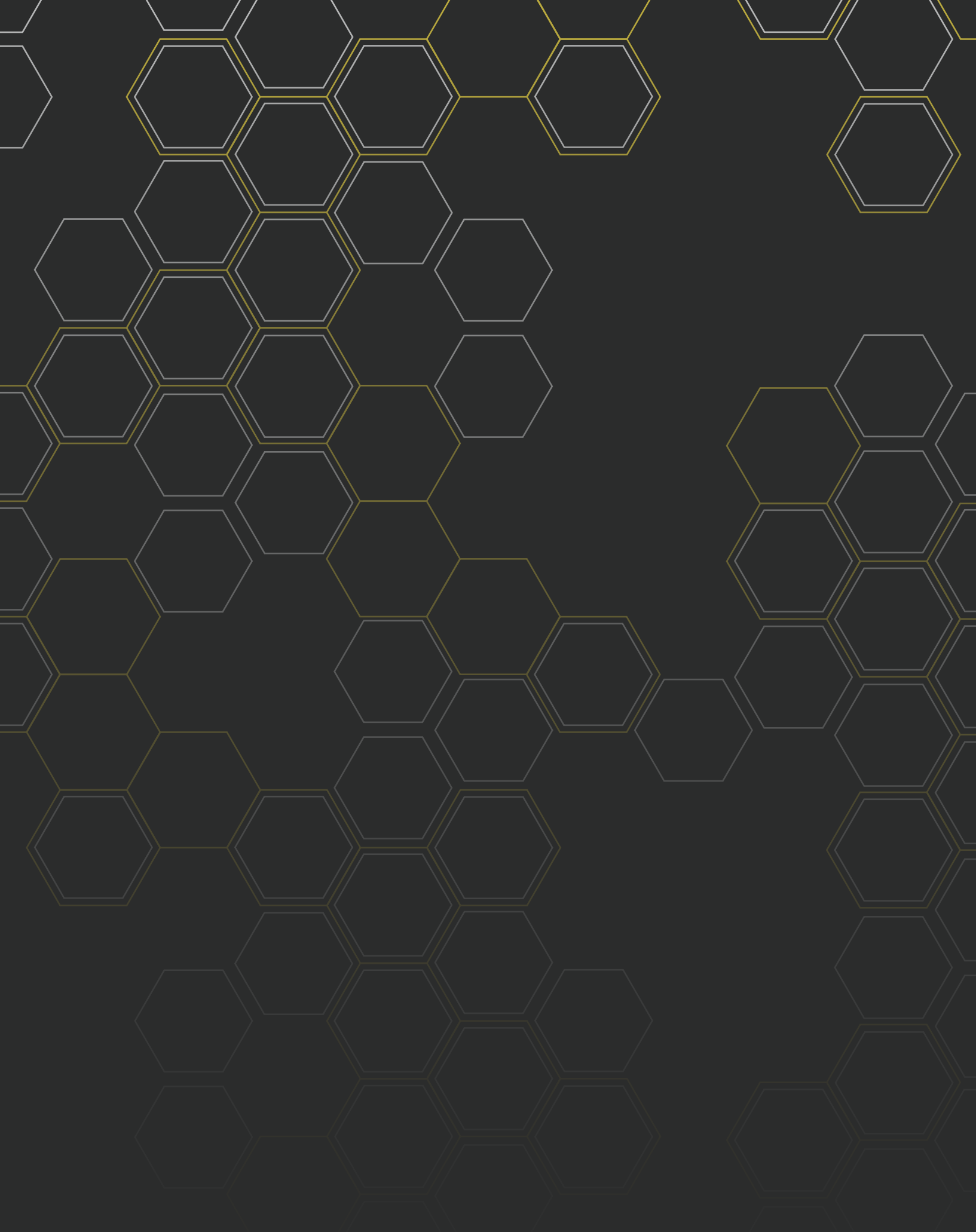



Document Title	PROTOS ADJUTOR Rigging Gear 2024
Applies To	PROTOS ADJUTOR Rigging Gear Products
Part Number	2024-001
Issue Number	03.24
Dated	11 March 2024

In the interest of continued product development. PROTOS reserves the right to alter product specification without prior notice.

PROTOS B.V.

+31 512 202 004
Ampèrelaan 9
9207 AM Drachten
Netherlands

WWW.PROTOS-ONE.COM

